

Model

- Plaza 2030
- Included model in this configuration:
 - Plaza 1230
 - Plaza 1530
 - Plaza 1830
 - Plaza 2430

Construction

- Quality polished edge mirror
- 5 MM Silver Backed Copper Free
- Installation Either Surface Mount (Side Mirror Trim Panels included) or Recessed
- Includes installation hardware

Codes/Standards Applicable

- Conforms to UL Std. 962
- Cert. to CSA Std. C22.2 No.250.0-08
- ETL Intertek 5004931



CABINET CONFIGURATION

- Included model in this configuration:
Plaza 1230 Plaza 1530
Plaza 1830 Plaza 2430

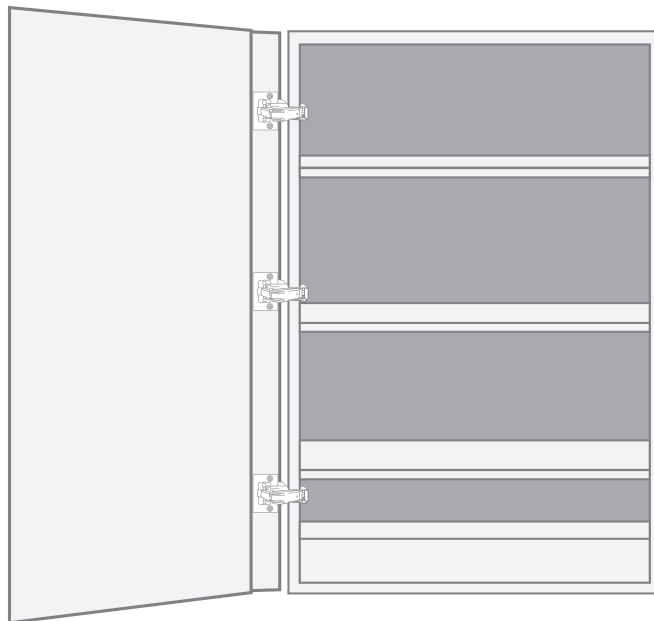

Plaza 2030 Medicine Cabinet - Specification Sheet

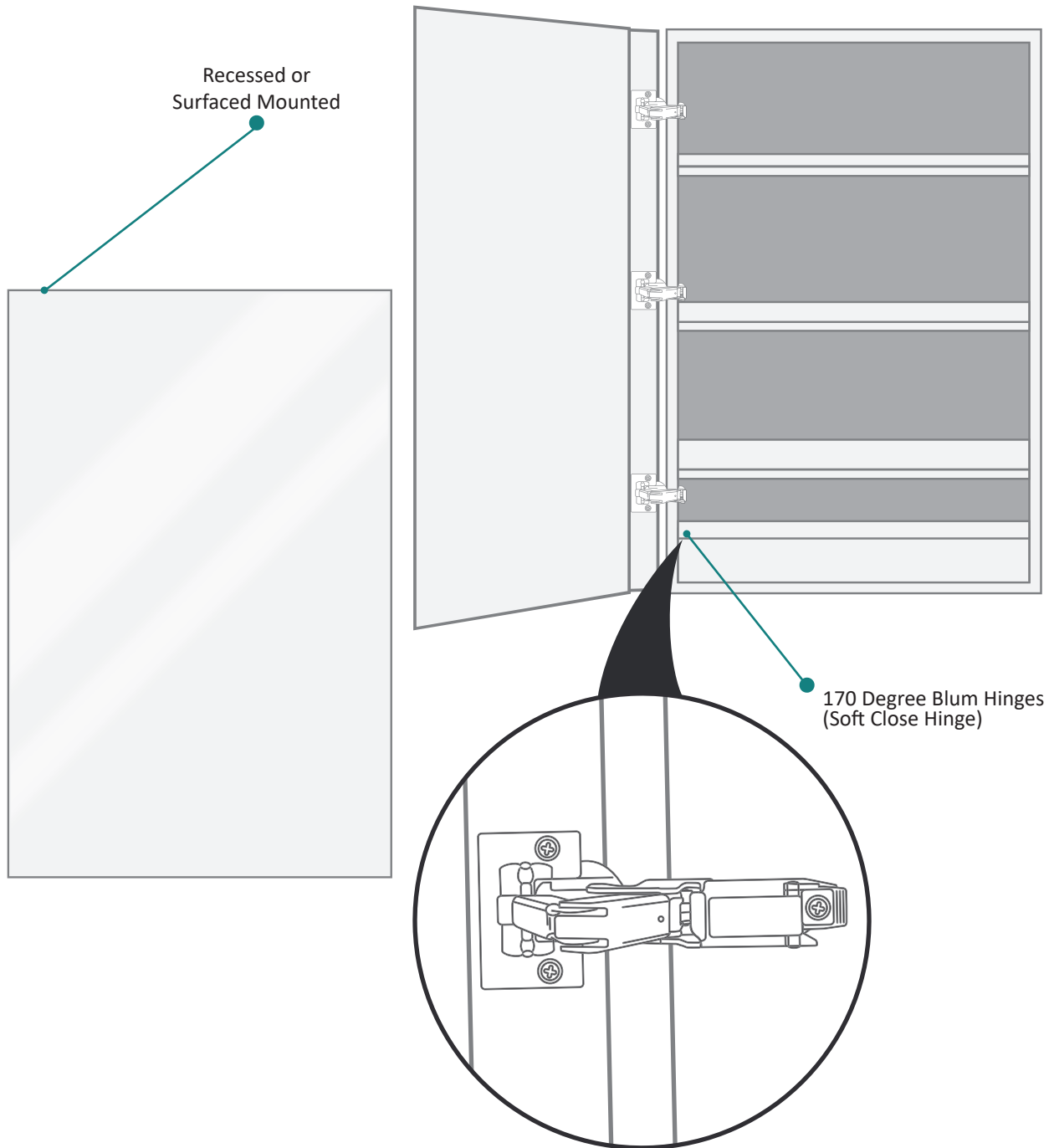

SURFACE MOUNT

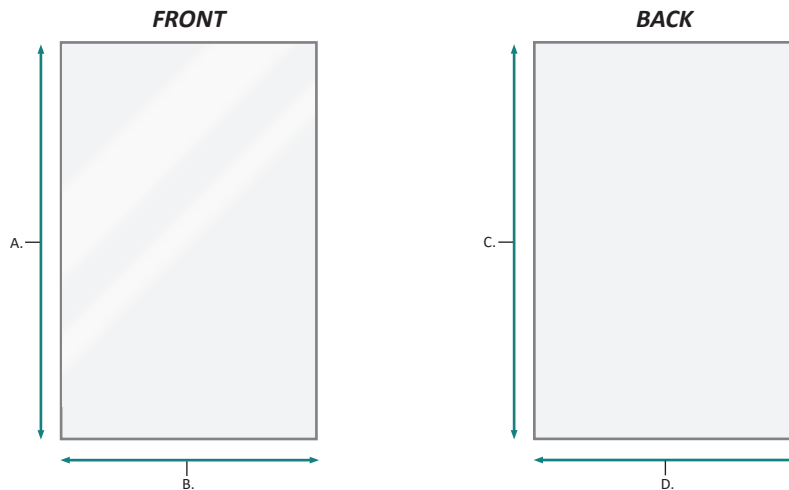
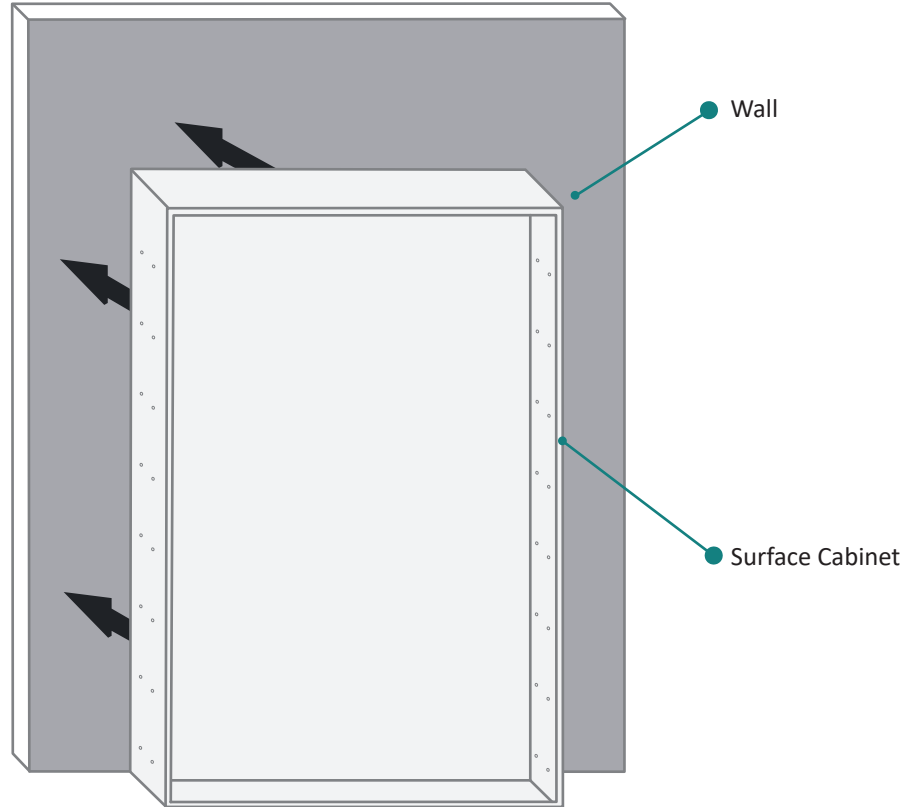

FRONT & BACK

MODEL	A	B	C	D
PLAZA2030	30	20	30	20

These measurements are for reference, for best results we suggest you measure actual product as small variations in size are possible

RECESS MOUNT

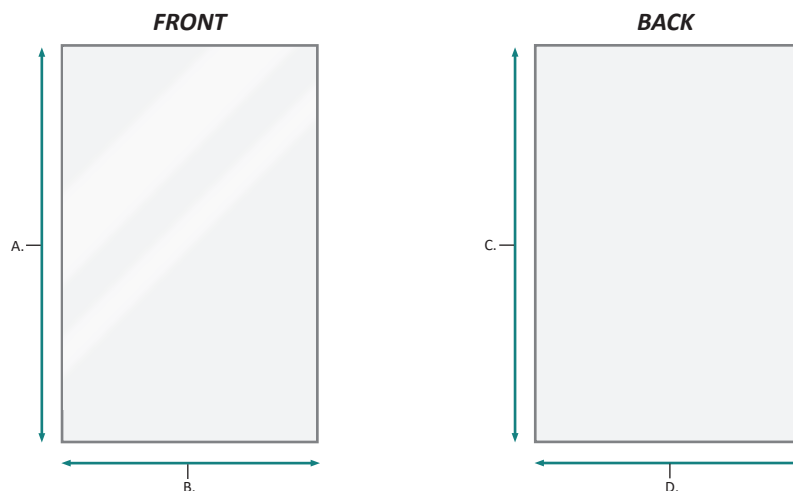
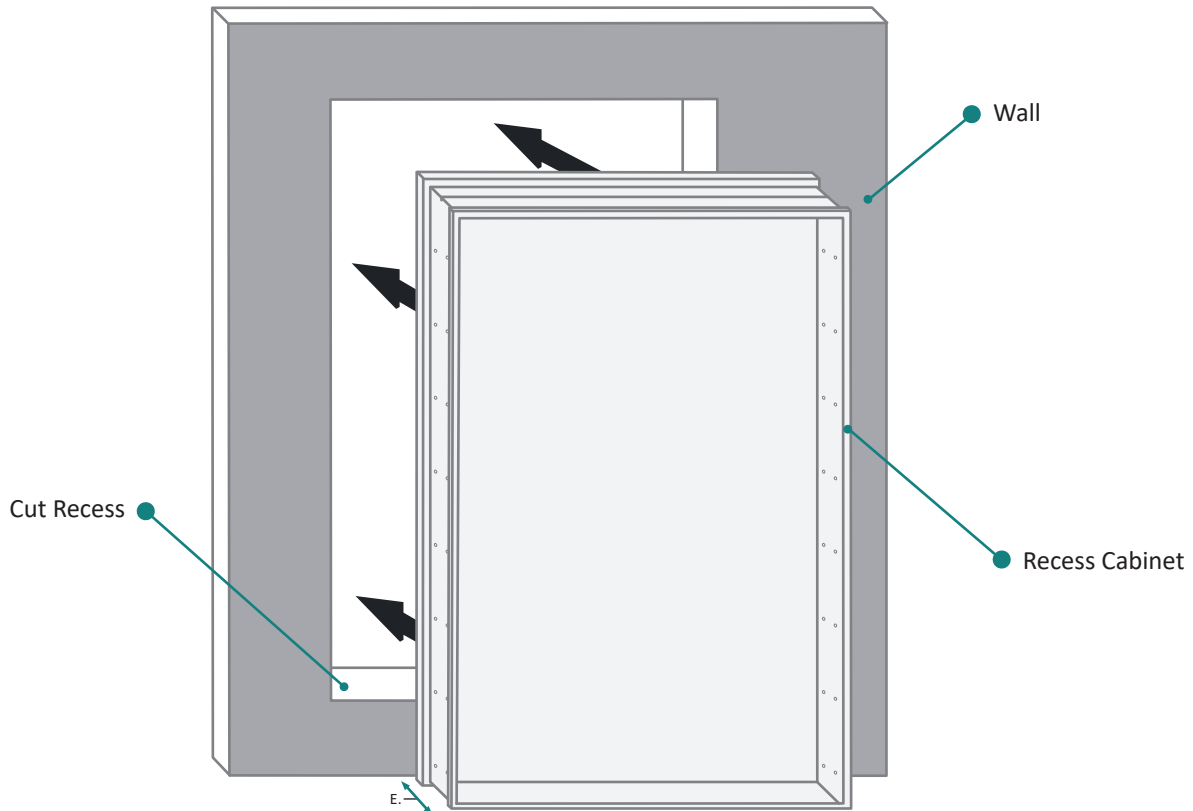

FRONT & BACK

MODEL	A	B	C	D	E
PLAZA2030	30	20	29-1/8	19-1/8	3-1/2

These measurements are for reference, for best results we suggest you measure actual product as small variations in size are possible

Plaza 2030 Medicine Cabinet - Specification Sheet

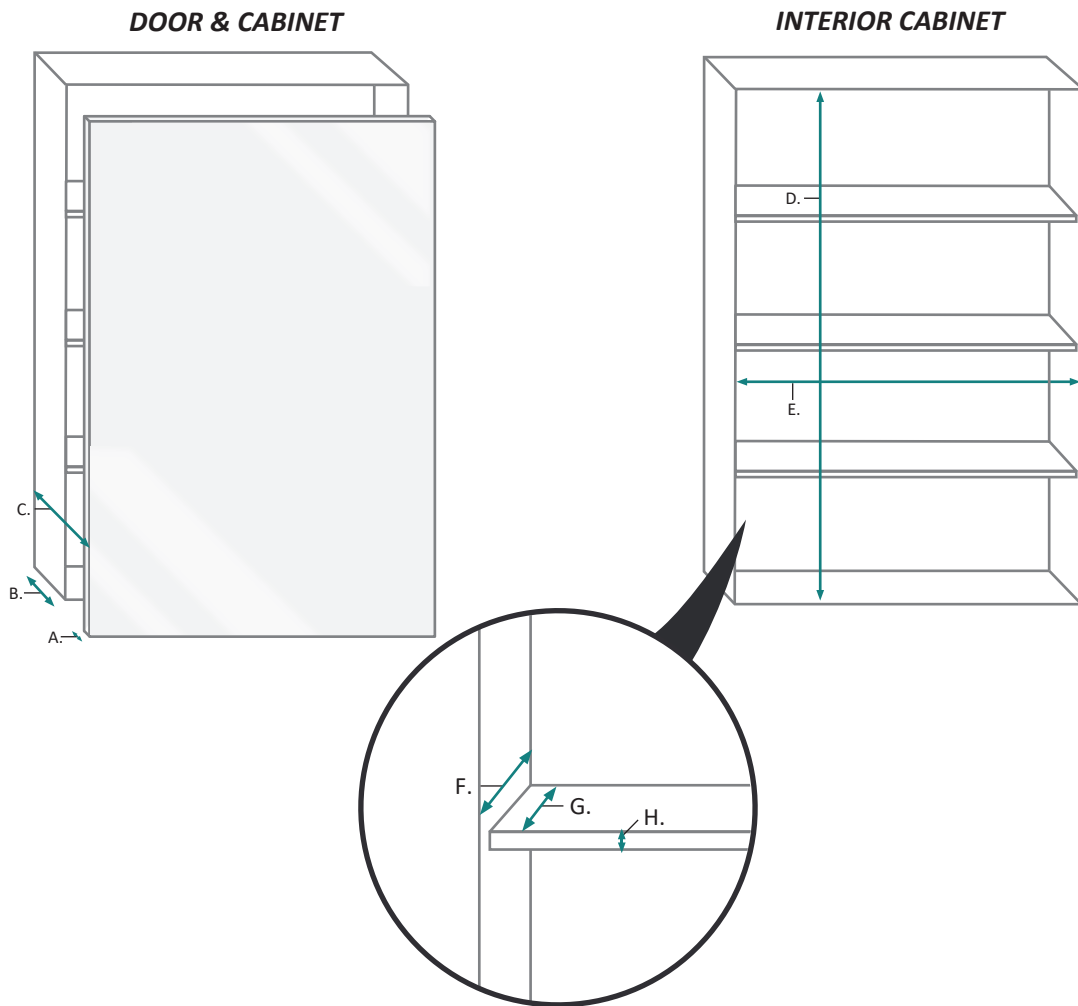

DOOR, CABINET & INTERIOR CABINET

MODEL	A	B	C	D	E	F	G	H
PLAZA2030	7/8	3-1/2	5	29-5/8	18-1/4	3-5/8	2-3/8	3/8

These measurements are for reference, for best results we suggest you measure actual product as small variations in size are possible